



TippingPoint™

Threat Protection System (TPS)

Hardware Specification and Installation Guide

Privacy and Personal Data Collection Disclosure

Certain features available in Trend Micro products collect and send feedback regarding product usage and detection information to Trend Micro. Some of this data is considered personal in certain jurisdictions and under certain regulations. If you do not want Trend Micro to collect personal data, you must ensure that you disable the related features.

The following link outlines the types of data that the Security Management System collects and provides detailed instructions on how to disable the specific features that feedback the information.

<https://success.trendmicro.com/data-collection-disclosure>

Data collected by Trend Micro is subject to the conditions stated in the Trend Micro Privacy Policy:

https://www.trendmicro.com/en_us/about/legal/privacy-policy-product.html

Legal Notice

© Copyright 2020 Trend Micro Incorporated. All rights reserved.

Trend Micro, the Trend Micro t-ball logo, TippingPoint, and Digital Vaccine are trademarks or registered trademarks of Trend Micro Incorporated. All other product or company names may be trademarks or registered trademarks of their owners.

Publication: September 2020

Overview

The TippingPoint Threat Protection System (TPS) is a high-performance, enterprise-class solution that protects your network by scanning, detecting, and responding to network traffic according to the filters, action sets, and global settings maintained on each device by a client.

The TPS offers improved technology that is optimized for higher throughput, high resiliency, high availability, and network segment protection from both external and internal attacks.

You can install as many TPS security devices as you need to strategically protect your network enterprise zones. A local client on the device monitors and manages activity. Alternatively, you can manage devices by using the Security Management System (SMS) console.

Learn more about each TPS product in the following sections:

- [TPS TX Series devices](#)
- [TPS 2200T device](#)
- [TPS 440T device](#)

For information about the Virtual Threat Protection System (vTPS) virtual appliance, refer to that product documentation.

TPS TX Series devices

1100TX

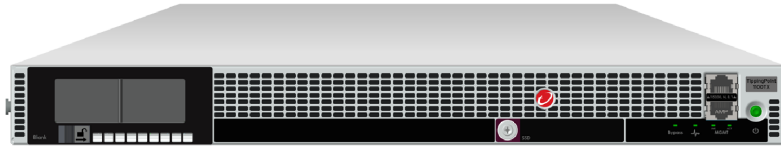

5500TX



8200TX



8400TX



The TPS TX Series security devices provide the following hardware features.

FEATURE	MODEL	DESCRIPTION
Ports	1100TX	<ul style="list-style-type: none"> One RJ-45 console port One 1 GbE copper management port
	5500TX	<ul style="list-style-type: none"> Two fixed SFP+ special purpose (SP) ports (not used in this TOS release) One RJ-45 console port One 1 GbE copper management port
	8200TX and 8400TX	<ul style="list-style-type: none"> Two fixed QSFP+ special purpose (SP) One RJ-45 console port One 1 GbE copper management port
Slots	1100TX	One I/O slot
	5500TX	Two I/O slots
	8200TX and 8400TX	Four I/O slots
Power supply	1100TX	One replaceable 250W AC power supply
	5500TX	Two hot-swappable, redundant 250W AC power supplies
	8200TX and 8400TX	Two hot-swappable, redundant 750W AC power supplies
External storage	1100TX	One 8 GB SSD
	5500TX, 8200TX, and 8400TX	One 32 GB SSD
Fans	1100TX	Two (nonreplaceable)
	5500TX	Three (nonreplaceable)
	8200TX and 8400TX	Seven (replaceable and hot-swappable)

TPS 2200T device

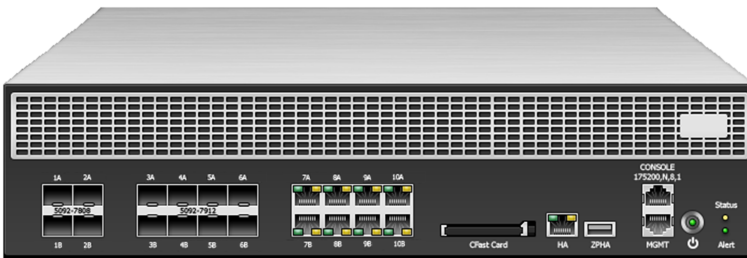

The TPS 2200T device provides the following hardware features.

FEATURE	2200T DEVICE
Ports	One RJ-45 console port One 1 GbE copper management port
1 GbE copper ports	8
1 GbE SFP ports	8
10 GbE* SFP+ ports	4
Power supply	2 hot-swappable 750W AC power supplies
External storage	One 8 GB CFast
System fans	3 fans (not replaceable)
Dedicated High Availability (HA) port	Yes
Zero Power High Availability (ZPHA)**	Built-in ZPHA for copper segments External ZPHA port for SFP and SFP+ segments

*Rate does not include autonegotiation. Dual-rate SFP+ transceivers are not supported.

**To learn more about installing and operating a ZPHA module, refer to *TippingPoint ZPHA Installation Guide – Modular and Non-Modular*.

TPS 440T device

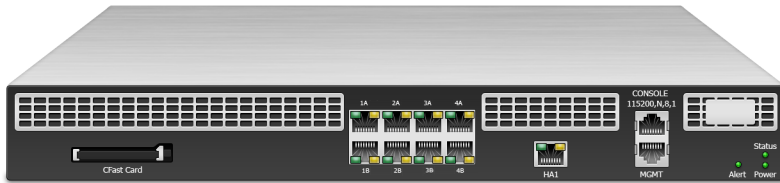

The TPS 440T device provides the following hardware features.

FEATURE	440T DEVICE
Ports	One RJ-45 console port One 1 GbE copper management port
1 GbE copper ports	8
Power supply	One 350W (built-in) power supply
External storage	One 8 GB CFast
System fans	3 internal fans (not replaceable)
Dedicated High Availability (HA) port	Yes
Zero Power High Availability (ZPHA)	Built-in ZPHA for copper segments

TPS 1100TX and 5500TX devices overview

The following topics describe the components, chassis, requirements, and installation specifics of the TPS 1100TX and 5500TX devices:

- [Chassis – front panel](#)
- [Chassis – rear panel](#)
- [Chassis – features](#)
- [Model requirements](#)
- [I/O modules](#)
- [Technical specifications](#)

[Learn more](#) about installing the device. Prior to installation, have the *TPS CLI Reference* available for configuration information.

Chassis – front panel

Refer to the following illustration for a front panel view of the TPS 1100TX and 5500TX devices:

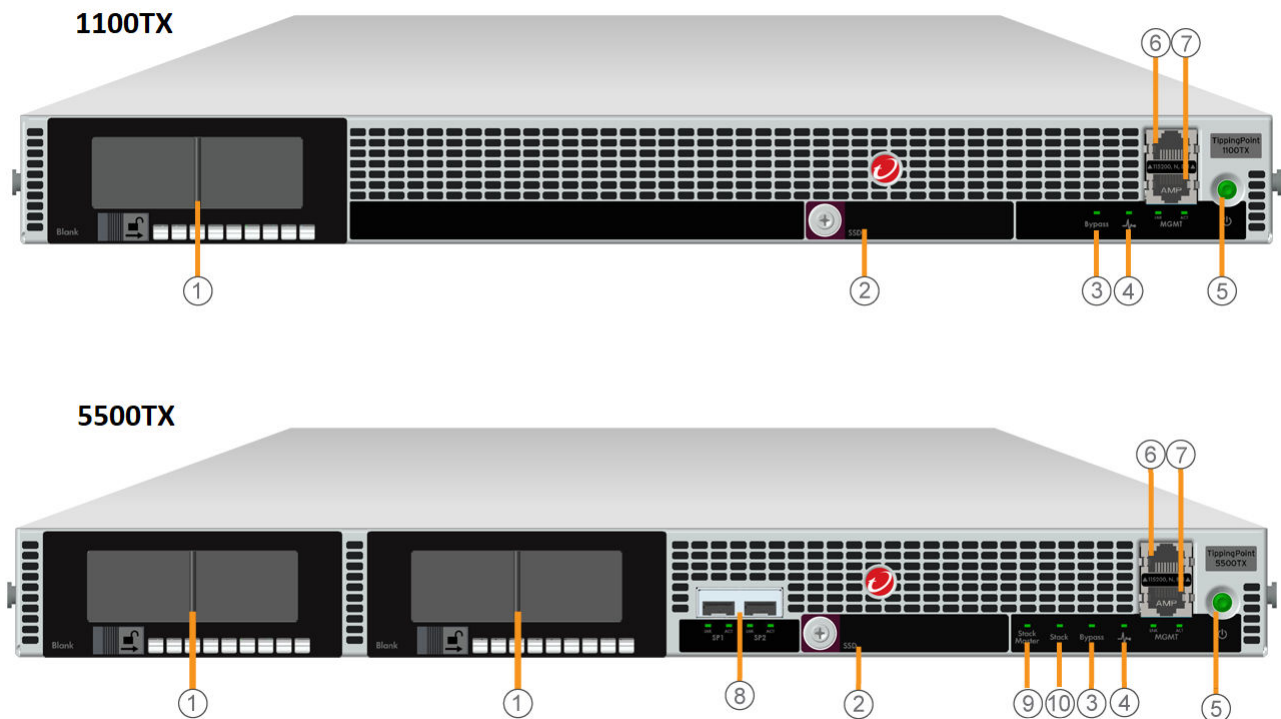

1. I/O modules
2. External storage 1.8-inch SSD (1100TX: 8 GB, 5500TX: 32 GB)

3. Bypass LED
4. Health LED
5. Power button
6. RJ-45 console port
7. GbE management port
8. Special purpose (SP) ports (not used in this TOS release)
9. Stack Master LED (not used in this TOS release)
10. Stack LED (not used in this TOS release)

Chassis – rear panel

Refer to the following illustration for a rear panel view of the TPS 1100TX and 5500TX devices:

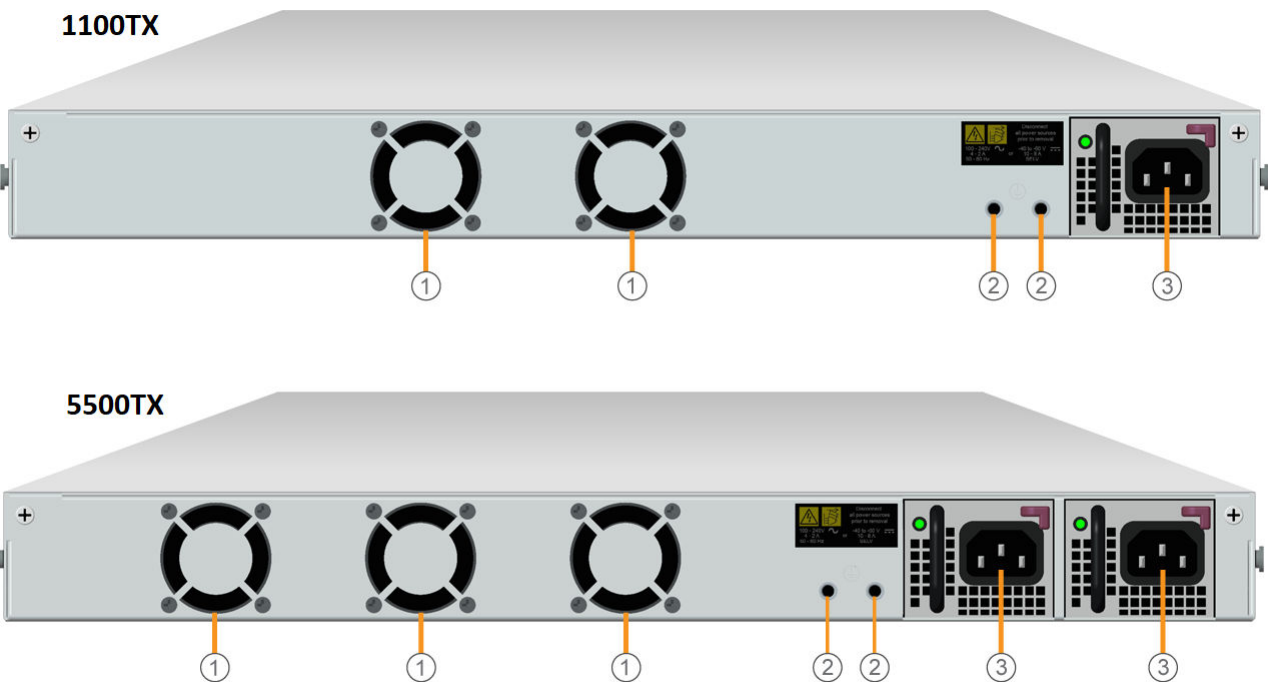

1. Fans
2. DC grounding lug screw holes (not used in this TOS release)
3. Power supplies

Chassis – features

Refer to the following topics for information about the TPS 1100TX and 5500TX chassis features:

- [Fans and power supplies](#)

- [External SSD](#)
- [Ports](#)
- [Chassis LEDs](#)

Fans and power supplies

The TPS 1100TX device includes:

- One replaceable power supply
- Two nonreplaceable fans

The 5500TX device includes:

- Two replaceable, hot-pluggable power supplies
- Three nonreplaceable fans

Learn more about [Power supplies](#) and [Fans](#).

External SSD

All TPS TX Series devices include an external SSD module that ships pre-installed with your product. The SSD is used to store traffic logs, snapshots, and other system data. You can remove and install the card while the device is running; however, to do so, you must issue the appropriate unmounting, mounting, and preparation commands from the device CLI.

[Learn more](#) about these external user disk commands.

Ports

All TPS TX Series devices come equipped with network slots for standard or bypass I/O modules.

In addition, the device provides a console and management port:

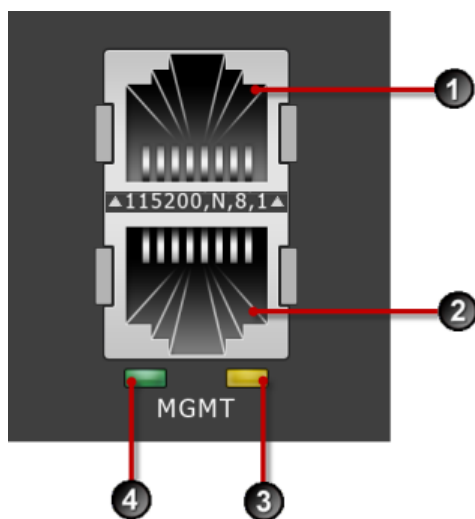

1. 1 RJ-45 serial console port
2. 1 GbE copper management port
3. Activity LED
4. Link LED

Chassis LEDs

When you turn on the device, the system completes a series of component checks and then displays LED indicators to show the status of each component:

- Stack Master status (5500TX devices; not used in this TOS release)
- Stack status (5500TX devices; not used in this TOS release)
- Bypass status
 - Solid red: The device is in Intrinsic High Availability (Intrinsic HA) Layer-2 Fallback (L2FB) mode.
 - Off: The device is not in L2FB mode.



System health status

- Flashing green: The system is booting up, and is not yet ready to inspect traffic.
- Solid green: The system is healthy.
- Red: The system is experiencing a health alert, such as a fan failure. This state resets to solid green when you view the system log.
- Management port status
 - Link LED: Solid green indicates that the port is linked and ready for data.
 - Activity LED: Flashing amber indicates that the port is passing data.

Model requirements

Refer to the following topics for specific requirements of the TPS 1100TX and 5500TX devices.

- [Power requirements](#)
- [Cabling requirements](#)

Power requirements

The TPS 1100TX and 5500TX devices require Alternating Current (AC) that meets the following requirements:

- Voltage: 100V to 240V
- Current: 4A to 2A
- Frequency: 47 Hz to 63 Hz (Tolerance: 50 Hz to 60 Hz)

The 1100TX ships with one power supply. The 5500TX device ships with two AC power supplies.

Cabling requirements

The TPS 1100TX and 5500TX devices ship with the following cables:

- An AC power cable for each power supply—one for the 1100TX device, two for the 5500TX device
- Null modem cable (USB to RJ-45) for the serial console management port

I/O modules

[Learn more](#) about the I/O modules for the TPS 1100TX and 5500TX devices.

Technical specifications

The TPS 1100TX and 5500TX devices have the following specifications.

SPECIFICATION	DESCRIPTION
Dimensions (unpackaged)	(1 U form factor) – 1.73 in x 18.54 in x 17.90 in (44 mm x 471 mm x 455 mm)
Weight	<ul style="list-style-type: none"> • 1100TX device – 14.5 lbs (6.58 kg) • 5500TX device – 17.5 lbs (7.94 kg)
AC Power Requirements	<ul style="list-style-type: none"> • Voltage: 100 to 240 • Current: 4 to 2 A • Frequency 47 to 63 Hz (Tolerance: 50 Hz to 60 Hz) <p>The device's maximum power consumption is 250 W.</p>
Service Provider operating requirements	<p>Temperature: 32 to 104° F (0 to 40° C) — Operating</p> <p>Temperature: -4 to 158° F (-20 to 70° C) — Storage</p>
	Altitude: No degradation up to 10,000 feet (3048 m)
	Humidity: 5% to 95% (noncondensing)
External interfaces	<ul style="list-style-type: none"> • One 1 GbE copper management port • One RJ-45 console port • (5500TX only) Two fixed 10 GbE SFP+ special purpose (SP) ports (not used in this TOS release) • Network slots: <ul style="list-style-type: none"> • 1100TX device – 1 slot • 5500TX device – 2 slots <hr/> <p> Note The second slot supports only the first four segments of a 6-segment I/O module.</p> <hr/> <ul style="list-style-type: none"> • 1 SSD slot

TPS 8200TX and 8400TX devices overview

The following topics describe the components, chassis, requirements, and installation specifics of the TPS 8200TX and 8400TX devices:

- [Chassis – front panel](#)
- [Chassis – rear panel](#)
- [Chassis – features](#)
- [Model requirements](#)
- [I/O module installation](#)
- [Technical specifications](#)

[Learn more](#) about installing the device. Prior to installation, have the *TPS CLI Reference* available for configuration information.

Chassis – front panel

Refer to the following illustration for a front panel view of the 8200TX (1 U) and 8400TX (2 U) devices:

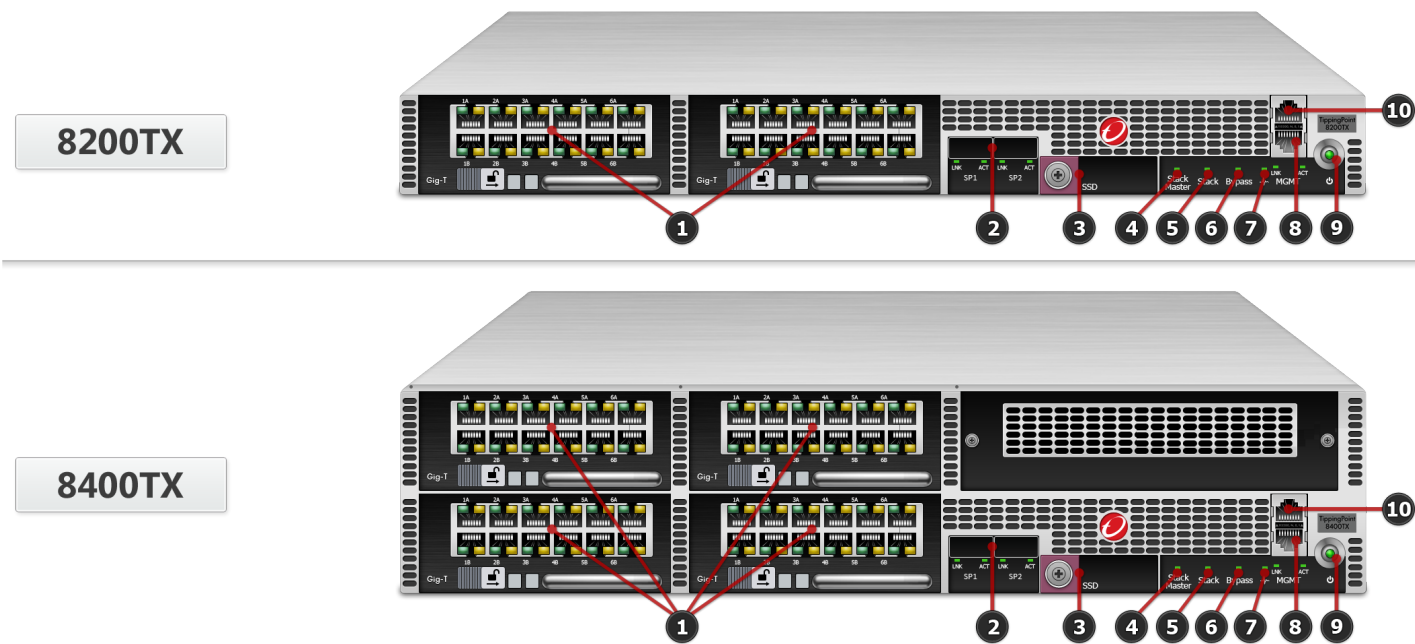

1. I/O modules
2. SP ports
3. External storage 1.8-inch SSD (32 GB)
4. Stack Master LED
5. Stack LED

6. Bypass LED
7. Health LED
8. GbE management port
9. Power button
10. RJ-45 console port

Chassis – rear panel

Refer to the following illustration for a rear-panel view of the TPS 8200TX and 8400TX devices.

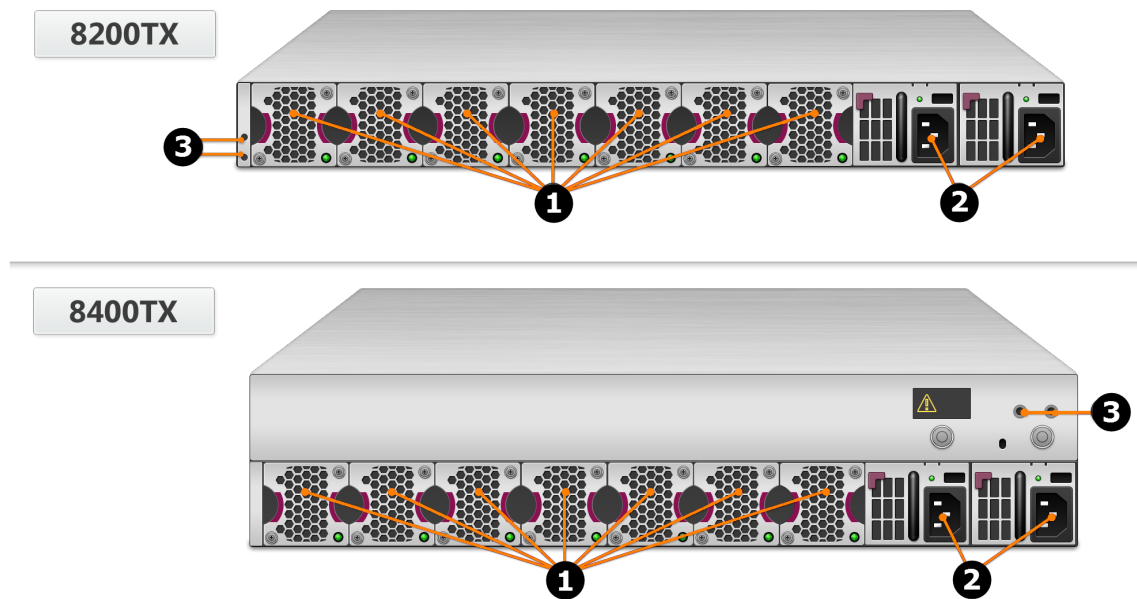

1. Fan modules - fans are numbered from left to right (Fan 1 is on the left; Fan 7 is on the right)
2. Power supply modules (Power supply 1 is on the left; Power supply 2 is on the right)
3. DC grounding lug screw holes

Chassis – features

Refer to the following topics for information about the 8200TX (1 U) and 8400TX (2 U) chassis features:

- [Fans and power supplies](#)
- [External storage card](#)
- [Ports](#)
- [Chassis LEDs](#)

Fans and power supplies

The TPS 8200TX and 8400TX devices include two power supplies and seven cooling fans. You can hot-swap these components. Learn more about [Power supplies](#) and [Fans](#).

External SSD

All TPS TX Series devices include an external SSD module that ships pre-installed with your product. The SSD is used to store traffic logs, snapshots, and other system data. You can remove and install the card while the device is running; however, to do so, you must issue the appropriate unmounting, mounting, and preparation commands from the device CLI.

[Learn more](#) about these external user disk commands.

Ports

All TPS TX Series devices come equipped with network slots for standard or bypass I/O modules.

In addition, the device provides a console and management port:

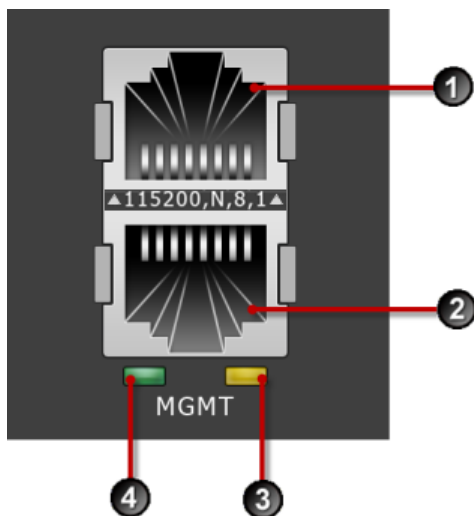

1. 1 RJ-45 serial console port
2. 1 GbE copper management port
3. Activity LED
4. Link LED

Chassis LEDs

When you turn on the device, the system completes a series of component checks and then displays LED indicators to show the status of each component:

- Stack Master status
 - Solid green: The device is the stack master.

- Off: The device is not the stack master.
- Stack status
 - Amber: The device is not ready to inspect network traffic.
 - Flashing green: The device is RTI but is not currently inspecting network traffic.
 - Solid green: The device is RTI and is inspecting network traffic.
 - Off: Stacking is not enabled on the device.
- Bypass status
 - Solid red: The device is in Intrinsic High Availability (Intrinsic HA) Layer-2 Fallback (L2FB) mode.
 - Off: The device is not in L2FB mode.
-  System health status
 - Flashing green: The system is booting up, and is not yet ready to inspect traffic.
 - Solid green: The system is healthy.
 - Red: The system is experiencing a health alert, such as a fan failure. This state resets to solid green when you view the system log.
- Management port status
 - Link LED: Solid green indicates that the port is linked and ready for data.
 - Activity LED: Flashing amber indicates that the port is passing data.

Model requirements

Refer to the following topics for specific requirements of the TPS 8200TX and 8400TX devices.

- [Power requirements](#)
- [Cabling requirements](#)

Power requirements

The 8200TX and 8400TX devices require Alternating Current (AC) or Direct Current (DC) that meets the following requirements:

- AC: Voltage 100V to 240V; 12A to 6A; 47 Hz to 63 Hz
- DC: Voltage -40V to -60V; 24A to 16A

The 8200TX and 8400TX devices ship with two AC power supplies. Consult your TippingPoint account contact for more information if you require a DC power supply.

Cabling requirements

The TPS 8200TX and 8400TX devices ship with the following cables:

- Two AC power cables, one for each hot-swappable power supply

- Null modem cable (USB to RJ-45) for the serial console management port

I/O module installation

Use the following topics to set up the I/O modules supported in TippingPoint security devices:

- [Before you begin](#)
- [ESD requirements](#)
- [I/O module options](#)
- [Module LEDs](#)
- [I/O module replacement](#)
- [Supported transceivers and cables for TippingPoint I/O modules](#)

Before you begin

- Review the release notes for your product for any late-breaking changes to the installation instructions.
- Read and follow all safety information listed in the *TippingPoint Hardware Safety and Compliance Guide* that shipped with your product.
- Complete the installation of your TippingPoint security device.

ESD requirements

Damage from Electrostatic Discharge (ESD) can occur when you handle electronic components improperly. Improper handling can also result in complete or intermittent system failures. Use proper ESD protection whenever you handle equipment. Following these general grounding guidelines:

- Always use an ESD wrist strap when you add or remove components from the chassis.
- Avoid touching the circuit boards or connectors on all cards and modules.
- Avoid contact between the printed circuit boards and clothing. The wrist strap only protects components from ESD voltages on the body. ESD voltages on clothing can still cause damage.

Place a removed component board-side-up on an antistatic surface or in a static-shielding container that is also grounded to the same point as the device. If you plan to return the component to the factory, immediately place it in a static-shielding container.

I/O module options

TippingPoint devices with module slots support both standard I/O modules and bypass I/O modules. Refer to the following table for fiber and copper components.

Only optical transceiver modules (including SFP, SFP+, and QSFP+) available from TippingPoint have been validated to achieve optimal performance with TippingPoint products. Other vendor devices are not supported. Using other vendor devices could be detrimental to proper operation of the TippingPoint system.







Bypass I/O modules are zero-power high-availability (ZPHA) modules that permit network traffic and services while bypassing the device entirely when the device loses power.







Note

For TX Series devices, consider the following I/O module restrictions:

- Fiber modules do not support auto-negotiation.
- If you use a 1000-BaseT copper SFP in the 6-Segment GbE SFP module, auto-negotiation will be available at 1000 Mbps.
- 10 GbE SFP+ modules support both SFP and SFP+ transceivers. If you plug SFP transceivers into SFP+ ports, only 1 Gbps speed will be available. Both 1 Gbps and 10 Gbps speeds can be configured with a multispeed SFP+ transceiver.

STANDARD I/O MODULES	BYPASS I/O MODULES
<p>6-Segment Gig-T</p>  <p>Ports: 12 Fixed RJ-45 copper ports Port speed: 10/100/1000 Mbps Part number: TPNN0059/TPNN0196</p> <hr/> <p> Note The second slot of the 5500TX device supports only the first four segments of a 6-segment I/O module.</p>	<p>4-Segment Gig-T Bypass Module</p>  <p>Ports: 8 copper ports Port speed: 10/100/1000 Mbps Part number: TPNN0070</p>
<p>6-Segment GbE SFP</p>  <p>Ports: 12 SFP ports Port speed: 1 Gbps Part number: TPNN0068</p> <hr/> <p> Note The second slot of the 5500TX device supports only the first four segments of a 6-segment I/O module.</p>	<p>2-Segment 1 G Fiber SR/LR Bypass Module</p>  <p>Ports: 4 Multi-Mode (SR)/Single-Mode (LR) Fiber (LC type)* *The TX/RX sides of each duplex-LC bulkhead port match those of standard SFPs. The top ports are each TX RX, and the bottom ports are each RX TX. Port speed: 1 Gbps Part number: TPNN0071 (SR)/TPNN0072 (LR)</p>

STANDARD I/O MODULES	BYPASS I/O MODULES
<p>4-Segment 10 GbE SFP+</p>  <p>Ports: 8 Fiber SFP+ ports Port speed: 10 Gbps Part number: TPNN0060</p>	<p>2-Segment 10 G Fiber SR/LR Bypass Module</p>  <p>Ports: 4 Multi-Mode (SR)/Single-Mode (LR) Fiber (LC type)*</p> <p>*The TX/RX sides of each duplex-LC bulkhead port match those of standard SFPs. The top ports are each TX RX, and the bottom ports are each RX TX.</p> <p>Port speed: 1/10 Gbps Part number: TPNN0073 (SR)/TPNN0074 (LR)</p>
<p>1-Segment 40 GbE QSFP+</p>  <p>Ports: 2 Fiber QSFP+ ports Port speed: 40 Gbps Part number: TPNN0069</p>	<p>1-Segment 40 GbE Fiber SR4/LR4 Bypass Module</p>  <p>Ports:</p> <ul style="list-style-type: none"> • 40 GbE-SR4 – 2 SR4 Multimode Ports (MPO Type) • 40 GbE-LR4 – 2 LR4 Singlemode Ports (LC Type) <p>Port speed: 40 Gbps Part number: TPNM0131 (SR4)/TPNM0132 (LR4)</p> <hr/> <p> Important Ensure that you upgrade your TX-Series device to TOS v5.2.0 or later before inserting the 40 GbE bypass module.</p>



CAUTION!

Handle all I/O modules with care. The bypass modules contain mechanical switches that are very sensitive to handling when not installed in the system. Network disruption can occur if handled improperly.

Module LEDs

Use the following table to learn about the states of each LED on the I/O module.

FEATURE	LED	COLOR	DESCRIPTION
Module health 	Status	Green Blinking Amber Solid Amber	The module is configured, in service, and in good health. The module has been inserted and powered up, but is not yet recognized by the software. The module is experiencing a fault.
Bypass 	Status	Off Green	Module in bypass. Module in normal mode (not in bypass).

**Note**

When you insert a 40 Gbps bypass module (BIOM) into a TX-Series TPS device that has not been upgraded to TOS v5.2.0, the module health status LED indicates that the module has experienced a fault (solid amber). To recover from this state:

1. Upgrade the device to TOS v5.2.0.
2. After the upgrade, perform a full reboot of the device.
3. Disable bypass on all BIOMs by selecting the normal option:
 - SMS: From the Device menu, click the device and select **Device Configuration -> HA (High Availability) -> Zero Power HA**.
 - LSM: Select **System -> High Availability -> Zero-Power HA**
 - CLI: `high-availability zero-power (bypass|normal) (slot|all)`

I/O module replacement

On a TPS TX Series device, *hot swapping* allows you to add, remove, or replace an I/O module without shutting down the device. When the device is turned on, you can hot swap an I/O module without interruption to the TPS device.

When you hot swap an I/O module, keep the following points in mind:

- Hot-swapping I/O modules during system initialization is not supported.
- The module port configuration is always reset.
- The module segment configuration, including link-down synchronization, Intrinsic HA, and inspection bypass, is always preserved. If you swap the module with a different type of module, be sure to verify that your segment configuration settings have persisted.

When the device is turned off, *cold swapping* allows you to add, remove, or replace an I/O module as you would when you hot swap. However, when you cold swap an I/O module, if the replacement module type is the same, the module port configuration is preserved.

When the device is managed by the SMS, a delay of up to 1 minute can occur before the SMS recognizes the changed I/O module.

When you insert a bypass I/O module, the bypass I/O module always starts up in bypass mode. A bypass I/O module remains in bypass mode until you remove it from bypass mode through the CLI, LSM, or SMS.

Rebooting the TPS does not change the bypass mode of the bypass I/O module. For information about how to use normal mode instead of bypass mode, refer to the SMS, LSM, or CLI documentation.

Supported transceivers and cables for TippingPoint I/O modules

For a list of supported transceivers and cables for TippingPoint I/O modules, refer to *I/O Modules Overview*.

Technical specifications

The TPS 8200TX and 8400TX devices have the following specifications.

SPECIFICATION	DESCRIPTION
Dimensions (unpackaged)	<ul style="list-style-type: none"> 8200TX device (1 U form factor) – 1.73 in x 18.54 in x 24.84 in (44 mm x 471 mm x 631 mm) 8400TX device (2 U form factor) – 3.46in x 18.54 in x 24.84 in (88 mm x 471 mm x 631 mm)
Weight	<ul style="list-style-type: none"> 8200TX device – 32 lbs (14.5 kg) 8400TX device – 50 lbs (22.7 kg)
Power Requirements	<ul style="list-style-type: none"> AC: Voltage 100 to 240; Current 12 to 6 A; Frequency 47 to 63 Hz (Tolerance: 50 Hz to 60 Hz) DC: Voltage -40 to -60, Current 24 to 16 A, SELV <p>The device’s maximum power consumption is 750 W.</p>
Service Provider operating requirements	<p>Temperature: 32 to 104° F (0 to 40° C) — Operating</p> <p>Temperature: -4 to 158° F (-20 to 70° C) — Storage</p>
	Altitude: No degradation up to 10,000 feet (3048 m)
	Humidity: 5% to 95% (noncondensing)
External interfaces	<ul style="list-style-type: none"> One 1 GbE copper management port One RJ-45 console port Two fixed QSFP+ special purpose (SP) ports Network slots: <ul style="list-style-type: none"> 8200TX device – 2 slots 8400TX device – 4 slots 1 SSD slot

TPS 2200T device overview

The following topics describe the components, chassis, requirements, and installation specifics of the TPS 2200T device:

- [Chassis – front panel](#)
- [Chassis – rear panel](#)
- [Chassis – features](#)

- [Model requirements](#)
- [Pluggable transceivers](#)
- [Technical specifications](#)

[Learn more](#) about installing the device. Prior to installation, have the *TPS CLI Reference* available for configuration information.

Chassis – front panel

Refer to the following illustration for a front panel view of the TPS 2200T 2 U form-factor device:

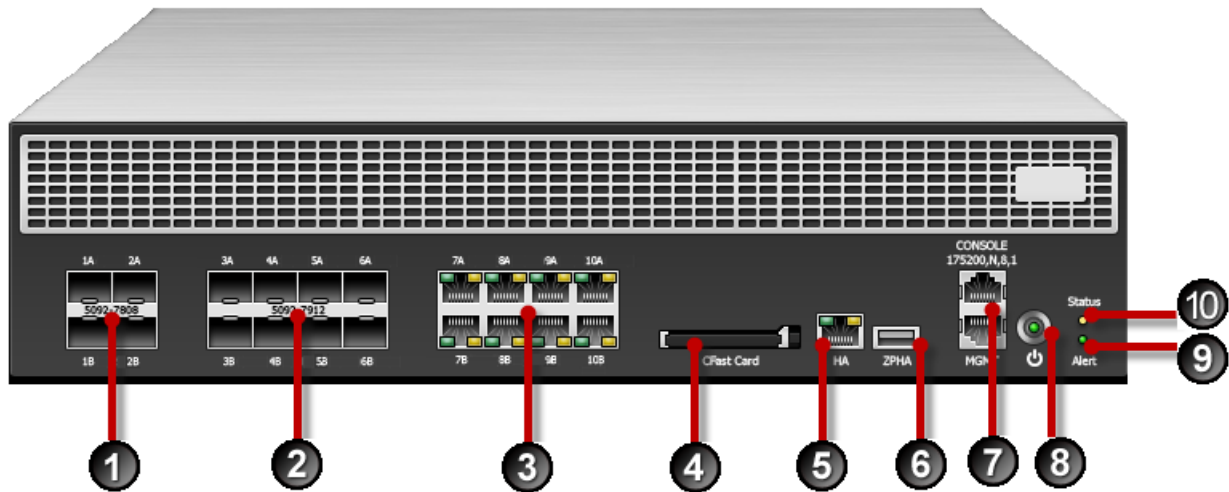

1. 10 GbE SFP+ ports
2. 1 GbE SFP ports
3. 1 GbE copper ports
4. External CFast card
5. Dedicated HA port
6. External ZPHA port
7. Console/Management port
8. Power button
9. Alert indicator
10. System status indicator

Chassis – rear panel

Refer to the following illustration for a rear-panel view of the TPS 2200T device.

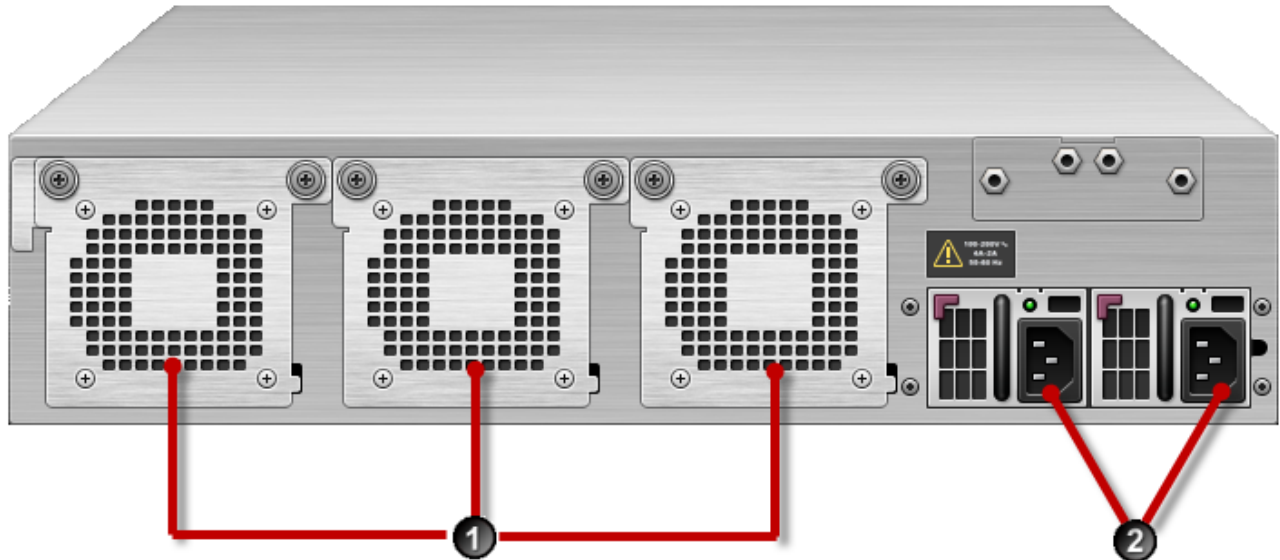

1. Fans (3)
2. Power supplies (2)

Chassis – features

Refer to the following topics for information about the TPS 2200T chassis features:

- [System status indicator](#)
- [Alert indicator](#)
- [Fans and power supplies](#)
- [External storage card](#)
- [Ports](#)

System status indicator

Refer to the System Status indicator on the right side of the front panel to learn about the current operating status of the device.

- **Flashing Green** — Device is booting and is not yet ready to inspect traffic.
- **Solid Green** — Device is running in a healthy state.
- **Solid Yellow** — Device is running but has a health rating below the acceptable threshold.

Alert indicator

Refer to the Alert indicator on the right side of the front panel to learn whether the device is in L2FB mode or not.

- **Solid Yellow** — Device is in L2FB (including when rebooting).
- **Off** — Device is not in L2FB.

Fans and power supplies

The 2200T device includes two hot-swappable power supplies. [Learn more](#) about these power supplies.

The 2200T device includes three cooling fans. The fans for the 2200T device are redundant but *not* hot-swappable. If a failure to a fan module occurs, you must replace the entire device. [Learn more](#) about fans.

External storage card

The TPS 2200T device includes a CFast card slot. The external storage card is used to store traffic logs, snapshots, and other system data. You can remove and insert the card while the device is running; however, to do so, you must issue the appropriate unmounting, mounting, and preparation commands from the device CLI.

For more information, see [External user disk](#) or the *TPS CLI Reference* for command syntax.

Ports

The TPS 2200T device provides a console and management port as shown in the following figure.

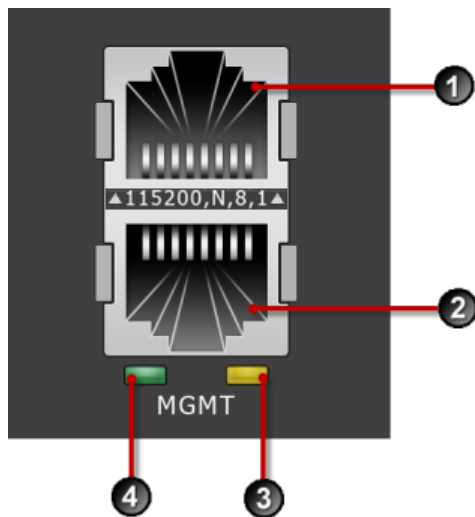

1. 1 RJ-45 serial console port
2. 1 GbE copper management port
3. Activity LED
4. Link LED

In addition, the 2200T device comes equipped with eight 1G copper ports, eight 1G SFP ports, and four 10G SFP+ ports. An external ZPHA device provides ZPHA bypass support for SFP/SFP+.

Model requirements

Refer to the following topics for specific requirements of the TippingPoint 2200T device.

- [Power requirements](#)
- [Cabling requirements](#)

Power requirements

The TPS 2200T device requires Alternating Current (AC) that meets the following requirements:

- AC: Voltage 100V to 240V; 12A to 6A; 47 Hz to 63 Hz

The TPS 2200T device ships with two AC power supplies.

Cabling requirements

The TPS 2200T device ships with the following cables:

- Two AC power cables, one for each hot-swappable power supply
- Null modem cable (USB to RJ-45) for the serial console management port

Pluggable transceivers

Use any of the following SFP and SFP+ pluggable transceivers with the TPS 2200T device:

- 1G SFP RJ45 T (Copper SFP)
- 1G SFP LC LX 10km 1310nm XCVR
- 1G SFP LC SX 550m 850nm XCVR
- 10G SFP+ LC SR*
- 10G SFP+ LC LR*

*Rate does not include autonegotiation. Dual-rate SFP+ transceivers are not supported.



Note

Only optical transceiver modules (including SFP and SFP+) available from TippingPoint have been validated to achieve optimal performance with TippingPoint products. Other vendor devices are not supported. Using other vendor devices could be detrimental to proper operation of the TippingPoint system.

The following table details the information for SFP and SFP+ transceivers.

FIBER INPUT	SIGNAL
Left side	Transmit
Right side	Receive

Technical specifications

The TPS 2200T device has the following specifications.

SPECIFICATION	DESCRIPTION
Dimensions (unpackaged)	2 U form factor – 3.46 in (H) x 16.77 in (W) x 18.80 in (D) (8.80 cm x 42.60 cm x 47.80 cm)
Weight	26.26 lbs (11.91 kg)
Power Requirements	AC: Voltage 100 to 240; Current 12 to 6 A; Frequency 47 to 63 Hz The appliance's maximum power consumption is 493 W.
Service Provider operating requirements	Temperature: 32 to 104° F (0 to 40° C) — Operating Temperature: -4 to 158° F (-20 to 70° C) — Storage
	Altitude: No degradation up to 10,000 feet (3048 m)
	Humidity: 5% to 95% (non-condensing)
External interfaces	<ul style="list-style-type: none"> • One 1 GbE copper management port • One RJ-45 console port • Eight 1 GbE copper ports • Eight 1 GbE SFP fiber ports • Four 10 GbE SFP+ fiber ports • One HA port • One ZPHA port • One CFast slot

TPS 440T product overview

The following topics describe the components, chassis, requirements, and installation specifics of the TPS 440T device:

- [Chassis – front panel](#)
- [Chassis – rear panel](#)
- [Chassis – features](#)
- [Model requirements](#)
- [Technical specifications](#)

For information about installing the device, [Learn more](#) about installing the device. Prior to installation, have the *TPS CLI Reference* available for configuration information.

Chassis – front panel

Refer to the following illustration for a front panel view of the TPS 440T device.

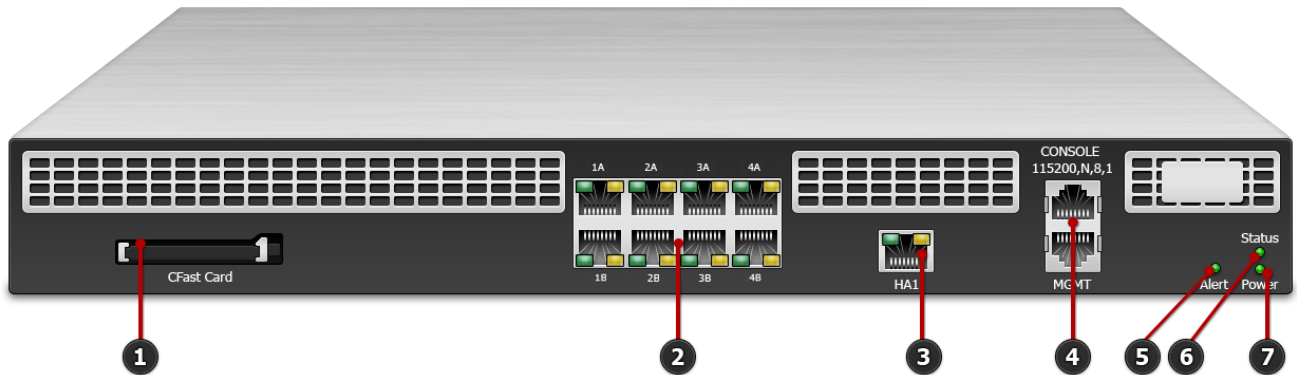

1. CFast card
2. 1 GbE copper ports
3. Dedicated HA port
4. Serial console port/Management port
5. Alert indicator
6. System status indicator
7. Power indicator

Chassis – rear panel

Refer to the following illustration for a rear-panel view of the TPS 440T device.



1. Fans (3)
2. AC power supply

3. AC power connector
4. Power switch

Chassis – features

Refer to the following topics for information about the TPS 440T chassis features:

- [System status indicator](#)
- [Alert indicator](#)
- [Fans and power supplies](#)
- [External storage card](#)
- [Ports](#)

System status indicator

Refer to the System Status indicator on the right side of the front panel to learn about the current operating status of the device.

- **Flashing Green** – Device is booting and is not yet ready to inspect traffic.
- **Solid Green** – Device is running in a healthy state.
- **Solid Yellow** – Device is running but has a health rating below the acceptable threshold.

Alert indicator

Refer to the Alert indicator on the right side of the front panel to learn whether the device is in L2FB mode or not.

- **Solid Yellow** – Device is in L2FB (including when rebooting).
- **Off** – Device is not in L2FB.

Fans and power supplies

The TPS 440T device includes one power supply and three internal cooling fans. These components are not customer-replaceable. [Learn more](#) about these components.

External storage card

The TPS 440T device includes a CFast card slot. The external storage card is used to store traffic logs, snapshots, and other system data. You can remove and insert the card while the device is running; however, to do so, you must issue the appropriate unmounting, mounting, and preparation commands from the device CLI.

[Learn more](#) about the external storage card.

Ports

The TPS 440T device comes equipped with eight copper ports. In addition, the device includes the console and management ports shown in the following figure.

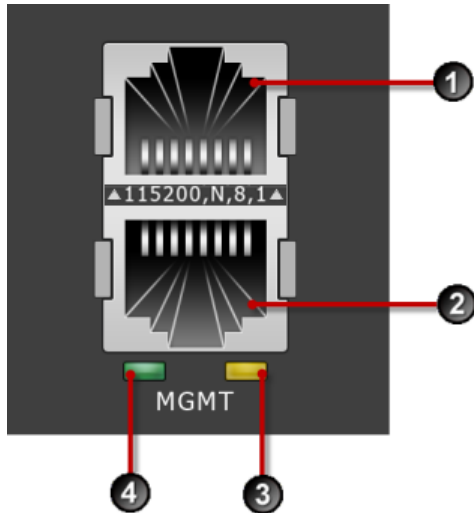

1. 1 RJ-45 serial console port
2. 1 GbE copper management port
3. Activity LED
4. Link LED

Model requirements

Refer to the following topics for specific requirements of the TPS 440T device.

- [Power requirements](#)
- [Cabling requirements](#)

Power requirements

The TPS 440T device requires Alternating Current (AC) that meets the following requirements:

- AC: Voltage 100V to 240V; 4A to 2A; 47 Hz to 63 Hz

The TPS 440T device ships with one AC power supply.

Cabling requirements

The TPS 440T device ships with the following cables:

- One AC power cable
- Null modem cable (USB to RJ-45) for the serial console management port

Technical specifications

The TPS 440T device has the following specifications.

SPECIFICATION	DESCRIPTION
Dimensions (unpackaged)	1 U form factor – 1.73 in (H) x 16.78 in (W) x 17.72 in (D) (4.40 cm x 42.62 cm x 45.00 cm)
Weight	15.28 lbs (6.93 kg)
Power Requirements	AC: Voltage 100 to 240; Current 4 to 2 A; Frequency 50 to 60 Hz The device's maximum power consumption is 250 W.
Service Provider operating requirements	Temperature: 32 to 104° F (0 to 40° C) — Operating Temperature: -4 to 158° F (-20 to 70° C) — Storage
	Altitude: No degradation up to 10,000 feet (3048 m)
	Humidity: 5% to 95% (non-condensing)
External interfaces	<ul style="list-style-type: none"> • One 1 GbE copper management port • One RJ-45 console port • Eight 1 GbE copper ports • One CFast slot

Install your TPS device

After you have completed preparation procedures and unpacked the TPS device, you can install and configure the components. Have the *TPS CLI Reference* available for configuration information reference. After installation of the hardware components, complete the initial setup wizard as part of the installation and configuration procedures.

Before installing your device, review and adhere to all safety guidelines described the *TippingPoint Hardware Safety and Compliance Guide*, which also contains detailed regulatory compliance information.

Follow these installation procedures:

- [Install the chassis](#)
- [Connect the power supply](#)
- [Attach the cables](#)
- [Run the setup wizard](#)

Install the chassis

Before installing your new security device, gather any necessary materials and prepare the network and hardware site. To carefully and correctly install the device, read through all preparation instructions and requirements. Use this general guideline information for all TippingPoint devices. For installation guidelines specific to your TPS device, refer to the appropriate *Install your security device* quick start for your model.

To install the device you must complete the following procedures:

- *Determine total rack space*
- *Attach the device to the rack*
- *Connect the power supply*

Determine total rack space

Before you install the chassis, determine the total rack space required to install your system. The total required rack space increases if you plan to install multiple systems.

The device fits in a 19-inch-wide rack (or a 23-inch-wide rack, with appropriate conversion parts available from rack accessory vendors). For more information about the dimensions of the device, refer to the technical specifications and requirements for your model.

Attach the device to the rack

Unpack the accessory kit and the slide rail assembly kit that shipped with your security device and review the installation documentation.

If the rack comes with stabilizers, install the stabilizers before mounting or servicing the unit in the rack.

If the rack is partially filled, load the rack from the bottom to the top with the heaviest component at the bottom. During initial installation, make sure to evenly distribute the weight so that the rack is stable.



Important

Always use a four-post mount for four-post racks. You can optionally order front mounting ears from TippingPoint to install the devices in two-post racks in front-mount or mid-mount positions. For more information, contact your TippingPoint representative.

If you plan to expand your system to include additional TippingPoint systems in the future, allow space in the rack for additions. During the initial installation, keep in mind the weight distribution and stability of the rack.

Connect the power supply

After you have bolted the device to the rack, attach the power supply AC connections. Do not turn on the device until you have completed all of the remaining installation steps.

The TPS 2200T, 5500TX, 8200TX, and 8400TX security devices require the use of one power cord to turn on the device. Use a second power cord for redundancy. For maximum protection, use different power circuit feeds for each power cord.

The TPS 440T and 1100TX devices provide a single power supply.

When you install DC power, always install the safety ground cable before connecting the power supply. For DC power connection details, refer to the *Install your power supply module* documentation.

To connect the power supply

Procedure

1. Locate the power inlets on the back of the chassis.
2. Plug the female end of a standard power cord into the power inlet. Plug the other end of the power cord into an AC outlet, power strip, or UPS.

Install the external storage card

For TPS 440T and 2200T security devices, install the CFast card that was packaged with your product into the empty slot on the front panel of the device. Use this pre-formatted, hot-swappable user disk to store system logs, snapshots, and other system data.

If the device has been set to require authentication for external user disks, complete the mounting process by using the command line interface (CLI). [Learn more](#).

The external SSD module comes pre-installed in the TX Series security devices. If you have a TPS TX Series device, you can skip this step.

Add the I/O modules - TPS TX Series

TPS TX Series devices come with blank modules inserted into I/O module slots. The 1100TX device provides one I/O slot, the 5500TX and 8200TX devices provide two I/O slots, and the 8400TX device provides four I/O slots.



WARNING!

Do not leave slots empty for an extended period of time. Insert a blank module or I/O module so that the device can be correctly cooled. [Learn more](#) about I/O module installation.

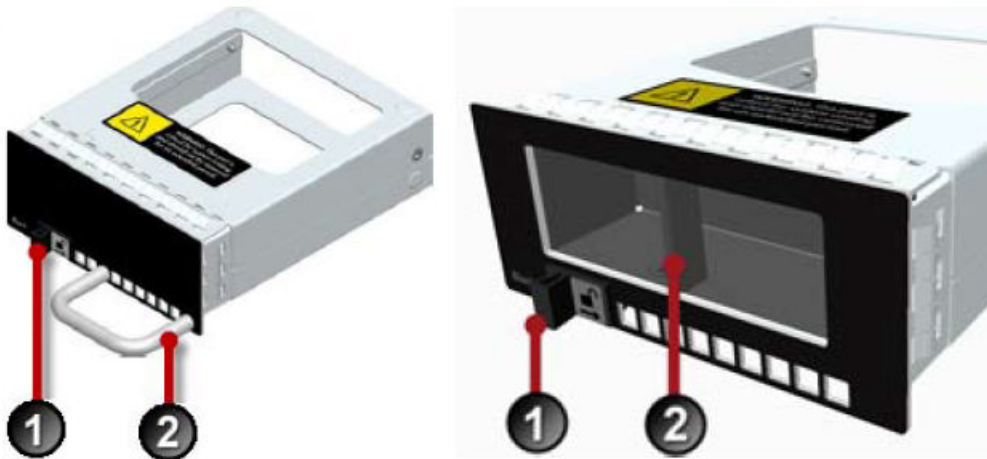

Procedure

1. To remove the blank module, slide the slide latch (1) to the right and pull on the handle (2 on left module) or grab point (2 on right module).



CAUTION!

Never lift your device using the module handles.

2. To insert an I/O module, slide the module into the empty module slot.

When the module is in the correct position, the slide latch automatically slides into position.

When you insert a bypass I/O module, the bypass I/O module always starts up in bypass mode. A bypass I/O module remains in bypass mode until you remove it from bypass mode through the CLI, LSM, or SMS. Rebooting the TPS device does not change the bypass mode of the bypass I/O module. For information about how to use normal mode instead of bypass mode, refer to the SMS, LSM, or CLI documentation.

Attach the cables

During initial setup, use the console port to access the setup wizard.

Connect the console port

Procedure

1. Connect the RJ-45 null modem cable to the console port on the front of the unit.
2. Connect the other end of your cable (standard USB connector) to your computer.

Use the following terminal settings for the console port:

- Baud rate: 115.2 Kbps
 - Character size: 8 bits
 - Parity: None
 - Stop Bits: One
 - Flow Control: None
-

Connect the management port

Procedure

1. Connect one end of the Category 5 Ethernet cable to the port labeled MGMT located on the front panel.
 2. Connect the other end of the Ethernet cable to your network. This enables remote management.
-

Turn on the device

After you have reviewed all requirements for operating your product, turn on the device:

- To turn on a TPS 440T device, flip the power switch on the back panel of the device.
 - To turn on all other TPS security devices, use the power button located on the front panel of the device.
-



Important

When you shut down the TippingPoint Operating System (TOS) using the `halt` command, the device still has power. Before you can restart a device in this state, *you must first remove power completely for 60 seconds*. For 440T devices, either unplug the device or turn off the power using the power switch on the back panel of the device. For 2200T and TX Series devices, you can remove power by holding down the front panel power button for 5 seconds.

Run the setup wizard

From the console terminal, complete the initial configuration by using the setup wizard. The wizard performs system checks and then prompts you to complete the initial setup.

After you run the setup, you can further configure your system using subsequent setup commands through the device CLI. See the *TPS Command Line Interface Reference* for detailed command descriptions.

1. Specify a security level (None, Low, Medium, or High). The security level you select determines your password complexity requirements.
2. Create an administrative account with the **SuperUser** role. The **SuperUser** role gives the account full access to the device. For more information about user accounts, review the documentation for your product.

The wizard prompts you to log in with your administrative account so that you can continue initial setup.

3. From the console port terminal, log in with your administrative account.
The wizard prompts you to configure IP address, default gateway, DNS server, and timekeeping options.

Install your license package

Install your license package on the device to provide the following product capabilities:

- Inspection throughput
- Digital Vaccine
- ThreatDV
- SSL inspection

You can install the license package using the SMS or LSM. For information about how to install the license package, refer to the user guide for whichever interface you use.



Important

After you install your license package, if prompted, reboot the device to apply any license updates.

Update your license package to assign a product capability that you have purchased, such as an inspection throughput license, to a particular security device. To review and manage the capabilities in your license package, go to the TippingPoint License Manager on the [TMC](#).

Verify your product license provides sufficient inspection throughput. By default, a TPS security device is unlicensed and provides reduced inspection throughput for testing and evaluation purposes only.

SECURITY DEVICE	UNLICENSED INSPECTION THROUGHPUT
1100TX	100 Mbps
5500TX	100 Mbps
8400TX	1 Gbps
8200TX	1 Gpbs
2200T	200 Mbps
440T	100 Mbps

Attach network connections

Attach your network cables to network segments on the device where appropriate.

Where to go next

After you attach network connections, network traffic passes through the device using the default filter configuration. The default configuration automatically recognizes and blocks traffic that is known to be malicious at all times, under all conditions, in all network environments.

On a TX Series device, any bypass I/O modules remain in bypass mode until you remove them from bypass mode through the CLI, LSM, or SMS. Rebooting the TPS does not change the bypass mode of the bypass I/O module. For information about how to disable bypass mode, refer to the SMS, LSM, or CLI documentation.

To complete your installation, refer to the *Release Notes* for your product. The *Release Notes* provide the latest post-installation information for your product.

You can perform additional configuration, administrative, and management tasks, by using:

- The LSM or the device CLI. The LSM and CLI enable straightforward management of a particular device.

**Note**

From the CLI, you can repeat the setup wizard by using the `setup` command. When you use the CLI, configure the terminal emulation package to transmit a Ctrl-H character when the Backspace key is pressed.

- The SMS. The SMS provides a scalable, policy-based operational model, and enables straightforward management of large-scale IPS and TPS deployments.

Power supplies

The following topics provide information for using the power supply modules:

- [AC power supply – TPS 2200T and TX Series](#)
- [DC power supply – TPS 8200TX and 8400TX devices](#)

**WARNING!**

Your product might have more than one power supply source. All power sources must be removed to de-energize the unit.

The TPS 2200T device has hot-swappable power supplies; there are no other serviceable parts inside. There are no hot-swappable or serviceable parts inside the TPS 440T device.

AC power supply – TPS 2200T and TX Series

The TPS 1100TX device includes one replaceable power supply module.

The TPS 2200T, 5500TX, 8200TX and 8400TX devices include two power supply modules. These modules are hot-swappable, redundant, and current-sharing, and the appliance can run with one active module.

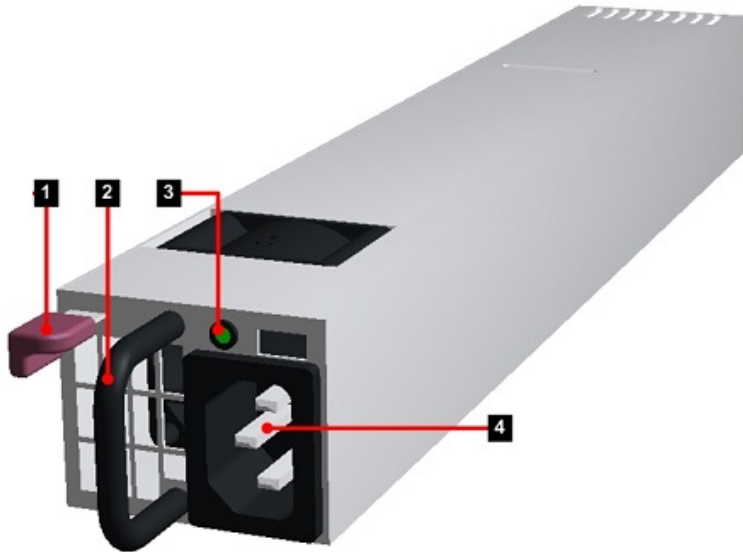

1. Removal Latch
2. Handle
3. Status LED
4. AC male power input

The Status LED is green when the module is powered and running normally.

Connect the AC power supply

When the AC power supply has been securely placed in the device, use the following procedure to connect power to the AC power supply:

Procedure

1. Locate the male power input on the back of the chassis.
2. Plug one end of a standard female power plug into the power input.
3. Plug the other end into an AC outlet, power strip, or UPS. Learn more about the power requirements for your product:
 - 1100TX and 5500TX devices – [Technical specifications](#)
 - 8200TX and 8400TX devices – [Technical specifications](#)
 - 2200T device – [Technical specifications](#)
 - 440T device – [Technical specifications](#)

The TPS device returns to its previous power-on state in the event of a power interruption. If power was on when the interruption occurred, the device automatically powers back on when the power is

reconnected; if power was off, the device stays off when the power is reconnected. If necessary, power on the device with the button on the front of the chassis.

DC power supply – TPS 8200TX and 8400TX devices

The TPS 8200TX and 8400TX devices are NEBS compliant and can accept a combination of AC and DC power supply units. Consult your TippingPoint account contact for more information on obtaining DC power supplies.



WARNING!

Do not attempt to install a DC power supply into a 440T device. The 440T device does not contain the grounding capability for safe installation of a DC power supply. Bodily harm and damage to the system could result.

Connect the DC power supply



WARNING!

When installing the product, always make the ground connection before applying power to the unit. You must ground this equipment to an external ground connection. Use a green and yellow 12 AWG ground wire to connect the host to earth ground during normal use. Disconnect the ground connection only after the unit is completely powered down.



CAUTION!

Do not attach a ground wire to the ground screw on the DC power supply module. Attach the ground wire to the DC grounding screw holes (0.63-inch hole spacing) with #10 screws. The DC grounding screw holes are located in the rear of the chassis.

The power supply LED is green when the module is powered and running normally.

When the DC power supply has been securely placed in the device, use the following procedure to connect power to the DC power supply.

Procedure

1. Locate the ground screw on the back of the chassis.

Refer to the following figure for the location.

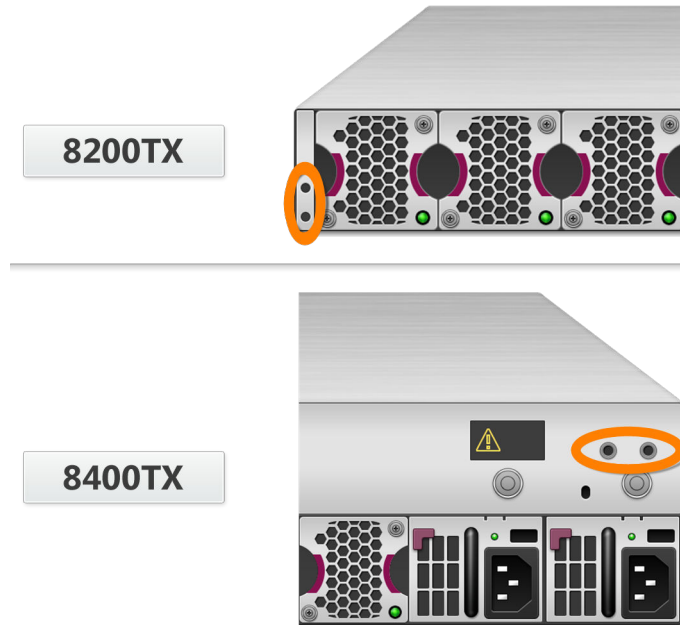

2. Attach a 12 AWG ground wire to the chassis ground strap mounting.
The wire should be crimped with a ring lug.
3. Locate the power input terminal block on the back of the module.
4. Attach the 12 AWG DC power wires to the power input terminal block labeled -48V and RTN.
The power wires should be crimped with lug spades to ensure a secure connection.
5. Connect the other side of the power cable to the SELV power source.
The power source should meet the following requirements:
 - Voltage: -40 to -60 V
 - 24 to 16 Amps
 - SELV
6. Depending on the BIOS settings and the state the device was in when the power was unplugged, the device might or might not turn on automatically when you reapply power. If necessary, power on the device with the button on the front of the chassis.

Fans

The 440T device includes five cooling fans (two of them are internal). The fans are not redundant or hot-swappable. If a failure to a fan module occurs, you must replace the entire device.

The 1100TX device includes two nonreplaceable cooling fans.

The 2200T and 5500TX devices include three cooling fans. The fans for these models are redundant but not replaceable. If a failure to a fan module occurs, you must replace the entire device.

The 8200TX and 8400TX devices include seven cooling fans. The fans for these models are redundant and hot-swappable. You can replace an individual fan without powering down the device.

The TPS TX Series Spare Fan (TPNN0266) is a replacement unit and can only be used with TPS TX Series devices.

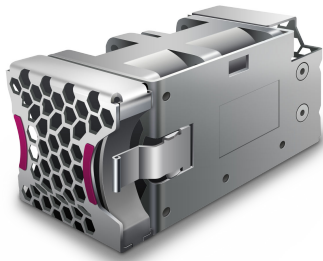

When a fan module fails or its RPM rate falls below a certain threshold, the system generates a warning or critical alarm message in its logs.

You can check fan performance by using:

- The LSM: **System Health > Monitor > Fan Speed**
- The device CLI: `show health fan`

Replace the fan – 8200TX and 8400TX devices only

The TPS 8200TX and 8400TX fan modules are hot-swappable and you can replace them when the device is operating.

After you identify the faulty fan module, follow these steps to replace the fan module. The fan modules are hot-swappable and can be replaced when the device is operating.

1. Press the release tab on the right side of the fan module and pull the module from its slot.
2. Set the faulty fan module aside.
3. Remove the new fan module from the packaging.
4. Align the new fan module with its open slot, and then slide the unit in until it is seated in the connector.

After you insert the fan module, the system verifies the fan speed. You can verify the performance by using the LSM: **System Health > Monitor > Fan Speed**.

Power cord retention bracket

The power cord retention bracket prevents the power cords from being too obtrusive. It also helps reduce strain on the power cord and power supply outlets.



Use the information in the following topics to manage the power cord retention bracket:

- [Install the retention bracket](#)
- [Attach the power cord retention bracket](#)
- [Remove the bracket](#)

Install the retention bracket

The following figure shows the back panel of a TPS 2200T device with the power cord retention bracket installed:

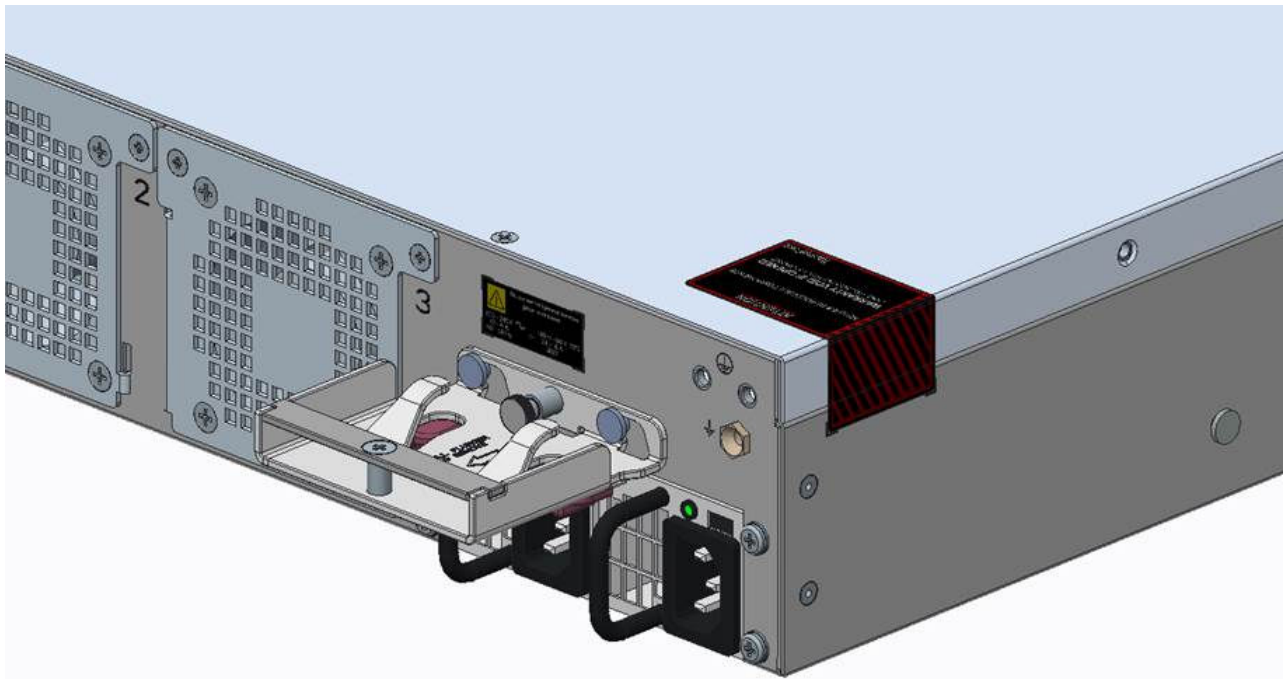

To install the retention bracket:

Procedure

1. Orient the bracket against the back surface of the chassis.
 2. Slide the bracket over the two shoulder rivets on the back of the chassis.
The spring-loaded plunger in the center of the bracket slides into place.
-

Attach the power cord retention bracket

Follow this procedure to attach the power cord to the retention bracket:

Procedure

1. Fold the power cable and slide it into the slot.

2. Push the folded cable into the slot until the cable loop goes past the sheet metal tabs.
 3. Secure the folded cable loop under the sheet metal tabs and attach the power cable to the power supply.
-

Remove the bracket

If you need to remove one of the brackets, pull the spring-loaded plunger in the middle of the bracket and slide the bracket up and off the shoulder rivets.

External user disk

The following topics provide information about the external user disk (CFast or SSD):

- [External SSD](#)
- [External CFast storage card](#)
- [External user disk commands](#)

External SSD

The TPS TX Series devices come with a pre-formatted external SSD.

Use the external SSD to store traffic logs, snapshots, and other system data.

Only SSDs available from TippingPoint have been validated to achieve optimal performance with TippingPoint products. Other vendor drives are not supported. Using other vendor drives could be detrimental to proper operation of the TippingPoint system.

Although you can replace the SSD when the system is operating, the SSD module is not designed to be removed on a regular basis.

If you replace the SSD module while the device is turned off, be sure to also restore power to the device so that you can mount the replacement disk. Failure to mount the replacement disk prevents the device from automatically mounting the disk when the device is rebooted.

Before you begin, determine whether the SSD module is faulty and needs to be replaced. When the SSD module fails, the system generates a warning or critical alarm message in the System log. To verify the state of the SSD module, run the `show health storage` CLI command, and then review the `/user disk` information. For more information about this command, see the *Command Line Interface Reference*.



CAUTION!

Before you remove the SSD, use the device CLI to first unmount the drive. Failure to properly remove the TippingPoint SSD can result in disk corruption and a system error. [Learn more](#) about using the external user disk commands.

To install the replacement SSD module:

1. If the device is turned on, enter the `user-disk unmount` CLI command to unmount the user disk.
2. From the front of the device, unscrew the fastener on the left side of the SSD module, and then pull the SSD module from its slot.

3. Set aside the faulty SSD module.
4. Remove the new SSD module from the packaging.
5. Align the new SSD module with its open slot and then slide the unit in until it is seated in the connector.
6. Tighten the fastener to lock the SSD module in place.
7. With the device turned on, mount the user disk so that the device can access the SSD file system.
 - To mount the user disk, enter the `user-disk mount` command.
 - To verify the user disk is mounted, enter the `show user-disk` command.

Failure to mount the user disk prevents the device from automatically mounting the disk when you reboot the device.

External CFast storage card

The TPS 440T and 2200T devices come with a pre-formatted external CFast storage card.

Use the 8 GB external CFast card to store traffic logs, snapshots, and other system data.

Only CFast cards available from TippingPoint have been validated to achieve optimal performance with TippingPoint products. Other vendor cards are not supported. Using other vendor cards could be detrimental to proper operation of the TippingPoint system.

You can replace the CFast card when the system is operating.



CAUTION!

Before you remove the card, use the device CLI to first unmount the user disk. Failure to properly remove the TippingPoint CFast card can result in disk corruption and a system error. [Learn more](#) about using the external user disk commands.

After you insert a new card into the CFast slot, be sure to mount the user disk using the device CLI. Failure to mount the user disk prevents the device from automatically mounting the disk when you reboot the device.

External user disk commands

The following table provides information about the commands used to manage the external user disk (CFast or SSD) in the CLI.

Refer to the *TPS CLI Reference* for detailed documentation of these commands.

COMMAND	DESCRIPTION
<code>user-disk format</code>	Formats the external user disk. This command erases any existing data on the external user disk.
<code>user-disk mount</code>	Manually mounts the external user disk. If you replace the external user disk while the device is turned off, be sure to also restore power to the device so that you can mount the replacement disk. Failure to mount the replacement disk prevents the device from automatically mounting the disk when you reboot the device.
<code>user-disk unmount</code>	Unmounts the external user disk so that the user can remove it.

COMMAND	DESCRIPTION
user-disk encryption enable	<p>Encrypts the external user disk if the system master key has been set. Changing the encryption status reformats the external user disk and erases all data on the drive.</p> <p>You can also configure master key and encryption controls using System > Settings > Data Security in the LSM. For more information, refer to the <i>TPS Local Security Manager User Guide</i>.</p>
user-disk encryption disable	<p>Disables encryption of the external user disk if the system master key has been set. Changing the encryption status reformats the card and erases all data on the drive.</p> <p>You can also configure master key and encryption controls using System > Settings > Data Security in the LSM. For more information, refer to the <i>TPS Local Security Manager User Guide</i>.</p>
show user-disk	<p>Shows properties of the external user disk, including operation status and capacity.</p>
master-key set	<p>Encrypts the external user disk and the system keystore by using the system master key. You are prompted to enter a master key that is between 9 and 32 characters in length, contains a combination of numbers and uppercase and lowercase letters, and that has at least one special character (for example, !@#).</p> <p>You can also configure master key and encryption controls using System > Settings > Data Security in the LSM. For more information, refer to the <i>TPS Local Security Manager User Guide</i>.</p>